

# Pneumatic Microinjector IM-11-2

How to adjust Pressure Speed Control (Response)

# Positioning of Control Knob



When the pressure relief valve is pressed, the syringe inside the injector becomes balanced immediately at one atmospheric pressure (1 atm.)

The control speed (Response) can be adjusted by the positioning of control knob, while holding down the valve.

# Positioning of Control Knob

Valve closed

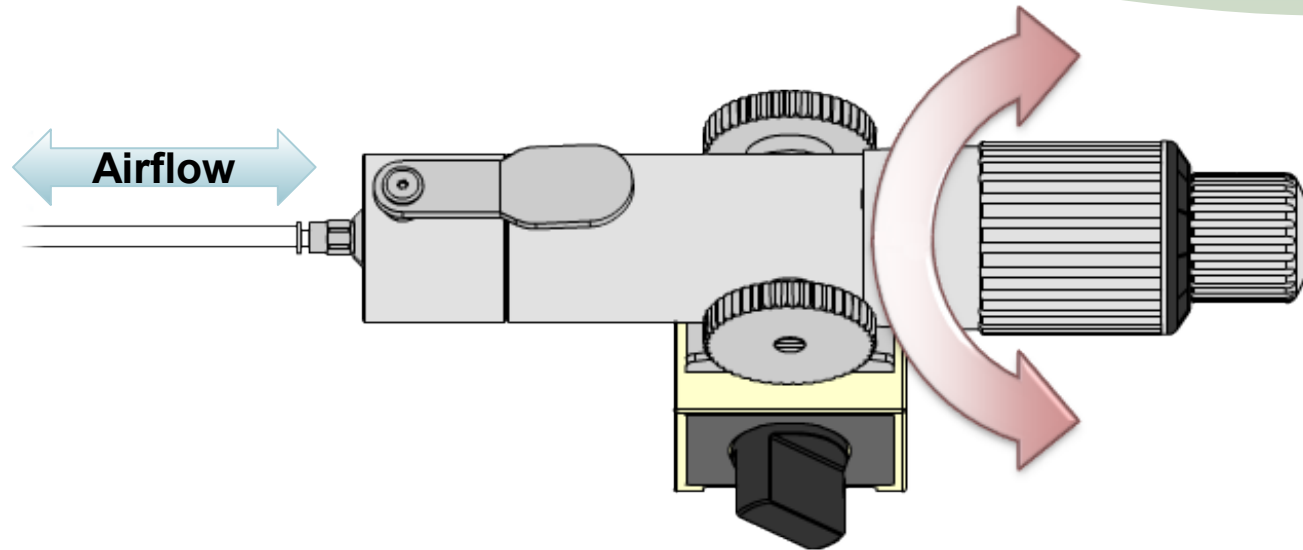

- \* When the pressure relief valve is closed, pressure can be controlled by rotating knobs from the injector to the pipette.

# Positioning of Control Knob

Valve opened

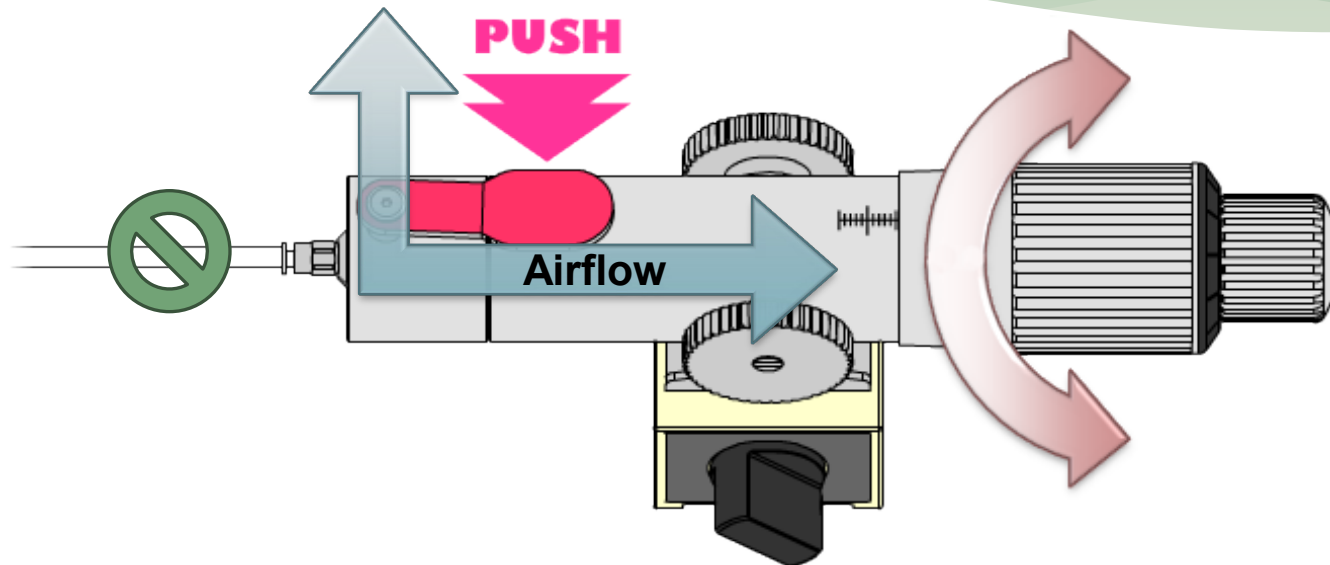

- \* As long as the pressure relief valve is opened, pressure can NOT be transmitted to the pipette at all, even if the control knobs are rotated.
- \* While the valve is held down, the volume of syringe inside the injector can be adjustable by re-positioning of the knob, by means of this, the control speed (response) can be adjustable.

# Positioning of Control Knob

## The difference of speed control

Response at the front position

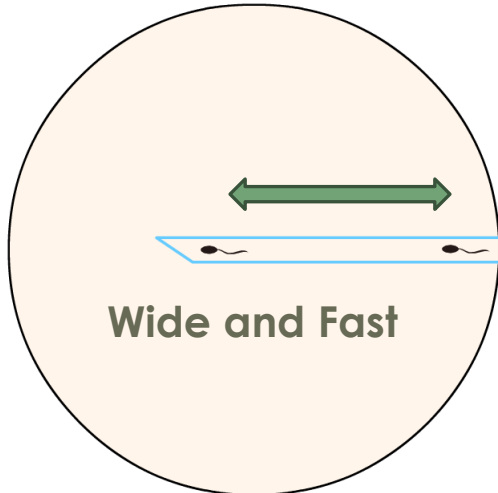
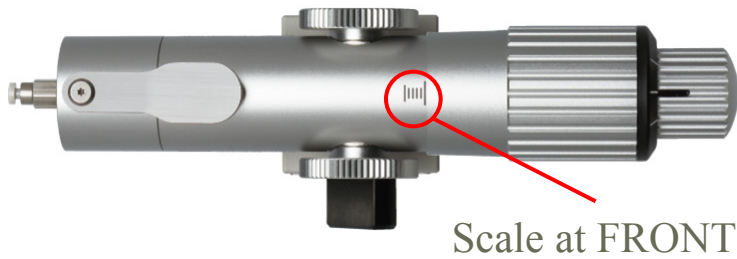

Response at the rear position

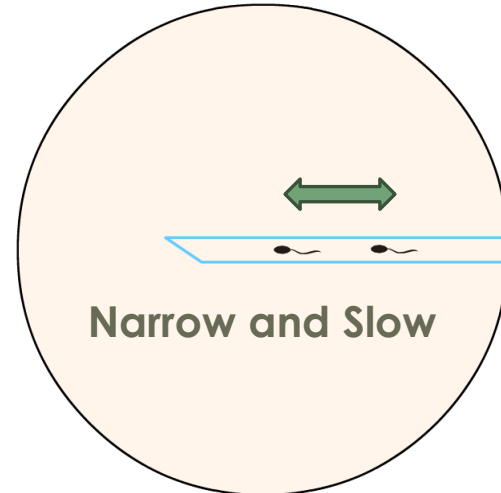
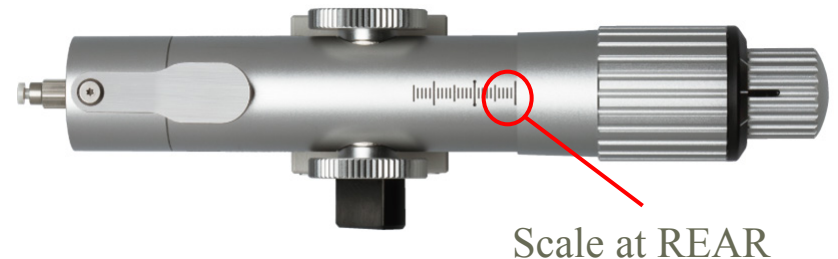

# Adjusting the interface



The control speed depends on the amount of the medium inside the pipette.

The proper way of adjusting the interface between oil and medium is described next.

# Adjusting the interface

1. Let's begin. The first illustration shows that there is only air inside the pipette, before the pipette is dipped into the cover oil.

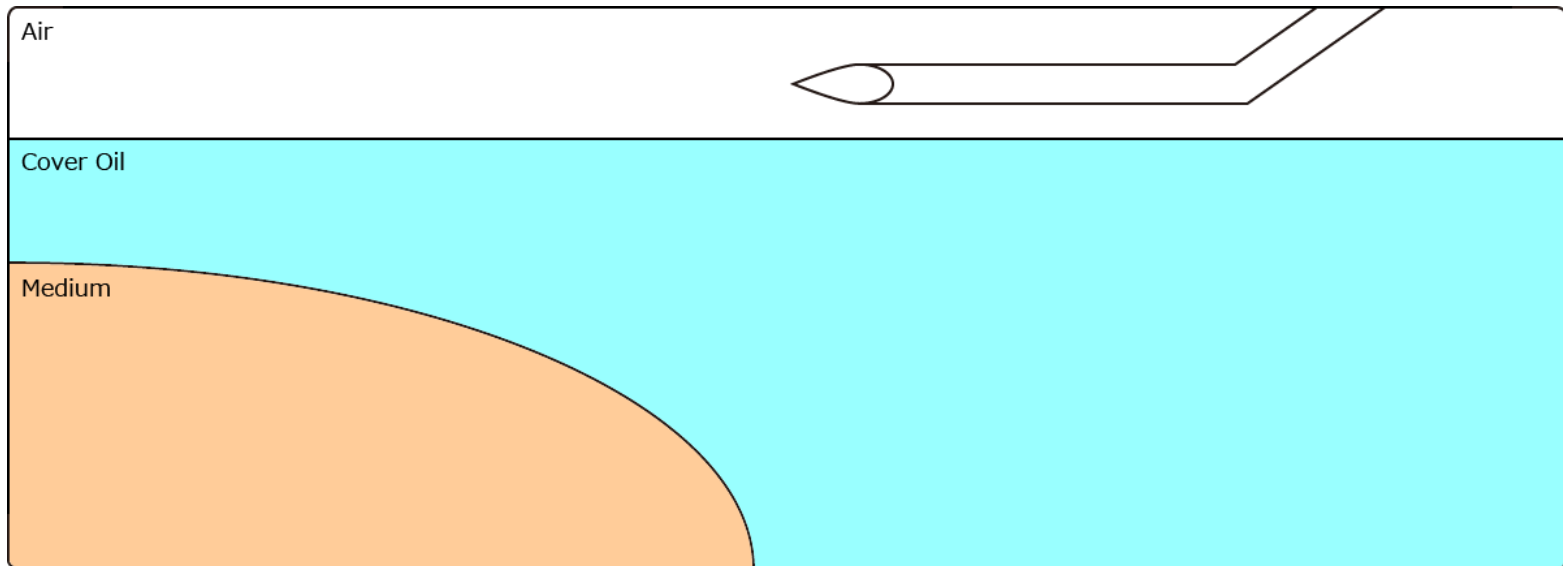

- ✓ Press the pressure relief valve to make the zero pressure at one atmospheric pressure (1 atm.)



# Adjusting the interface

2. When lowering the pipette by manipulator, the pipette soaks up cover oil by capillary action.

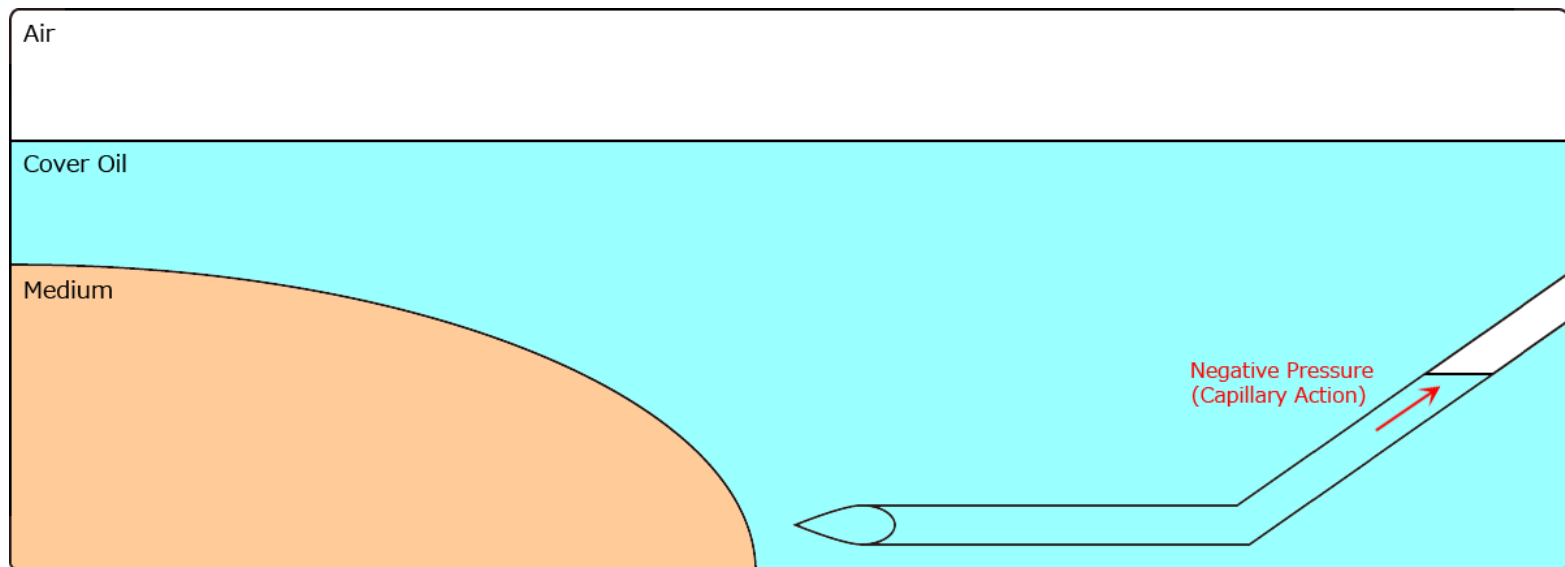

【Capillary action > Zero Pressure (at 1 atm.) ⇒ Soak up the oil】



# Adjusting the interface

3. By applying the positive pressure by injector, push the extra soaked-up cover oil out from the pipette. Stop it when the interface between cover oil and air can be viewed under the microscope.

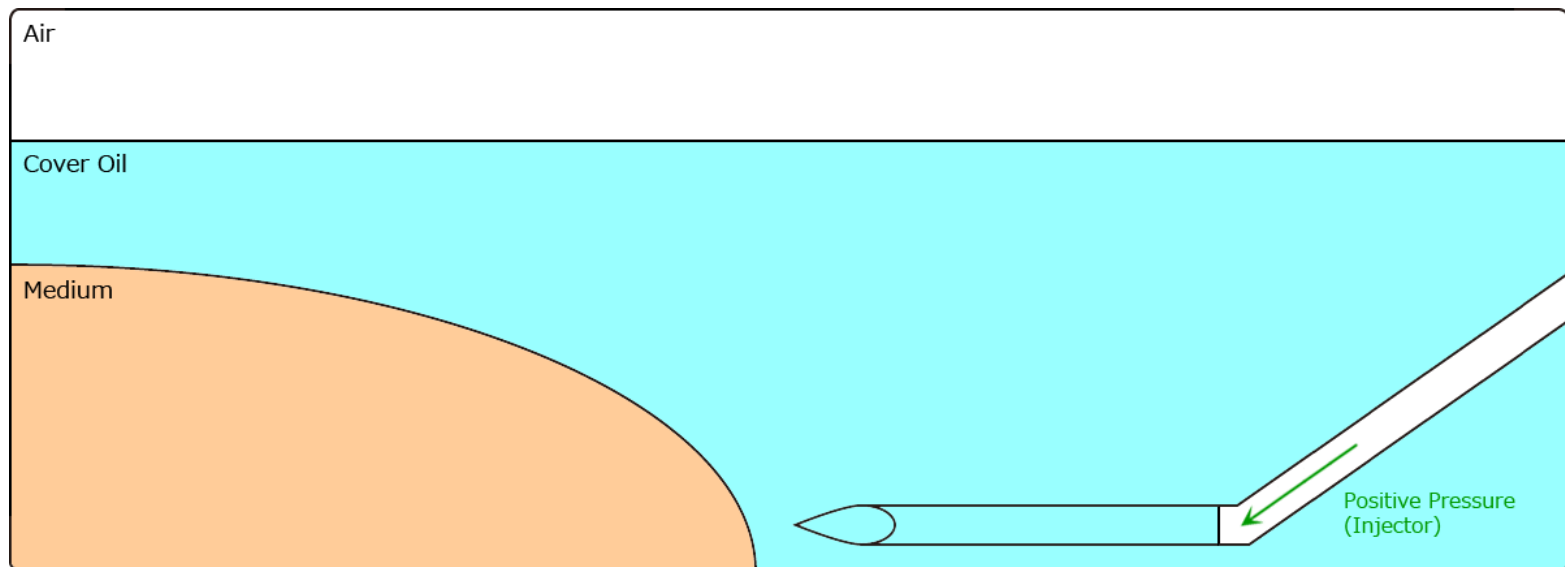

【Capillary action < Positive pressure  $\Rightarrow$  Push the oil out】

# Adjusting the interface

4. Move the stage, and let the pipette soak up the medium by capillary action. Turn the control knob counterclockwise, and stop it by the time the medium will be drawn into the middle of pipette. Make sure that the interface between the medium and cover oil can be viewed under the microscope.

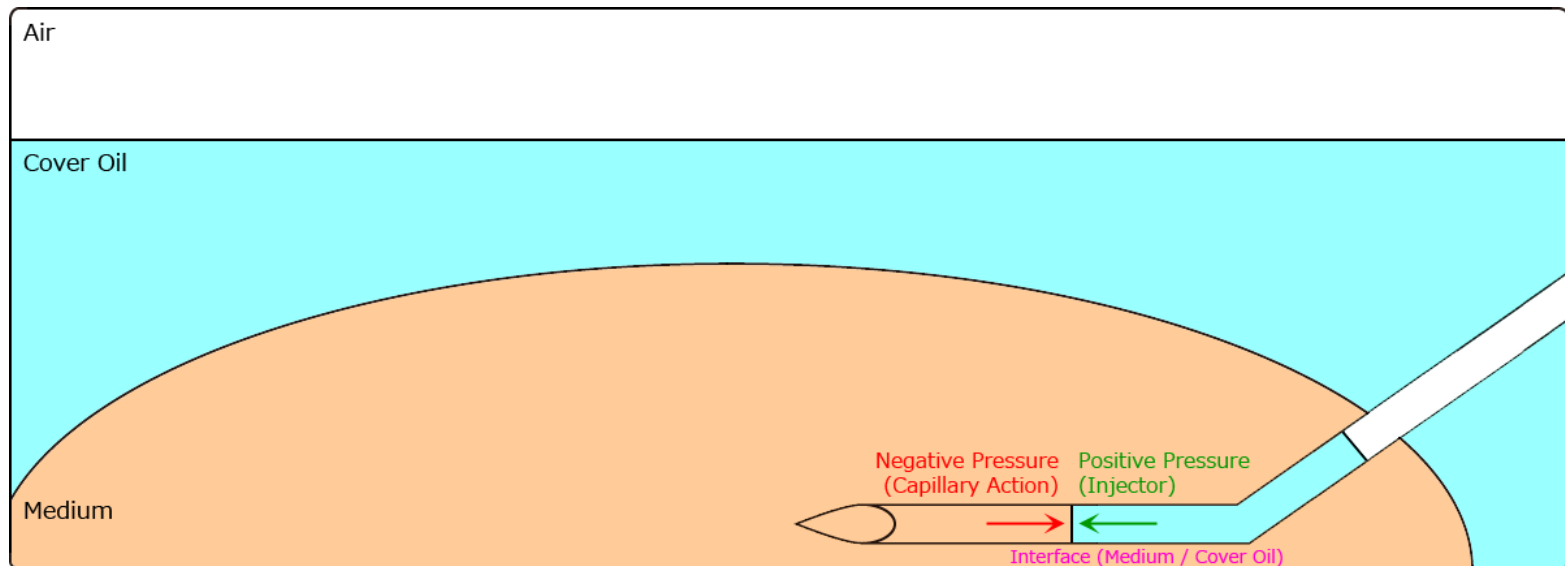

【Capillary action = Positive pressure  $\Rightarrow$  Interface gets balanced】

# Adjusting the interface

## GOOD

Interface is located under the bent section of pipette.

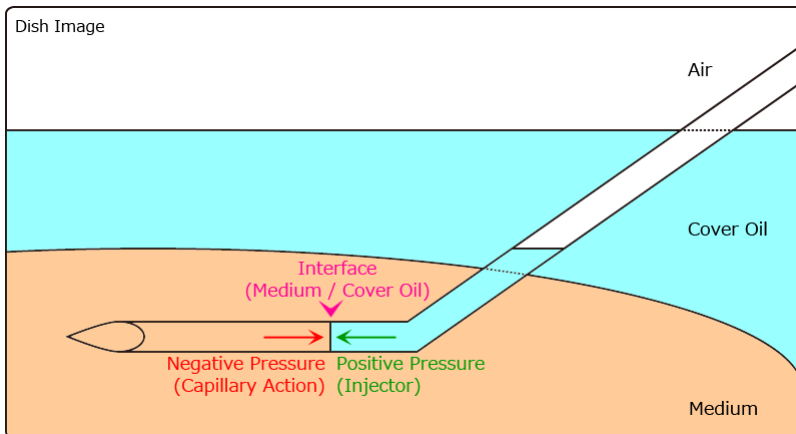

◎ Easy to control. Comfortable speed.

## NO GOOD

Interface is located above the bent section of pipette.

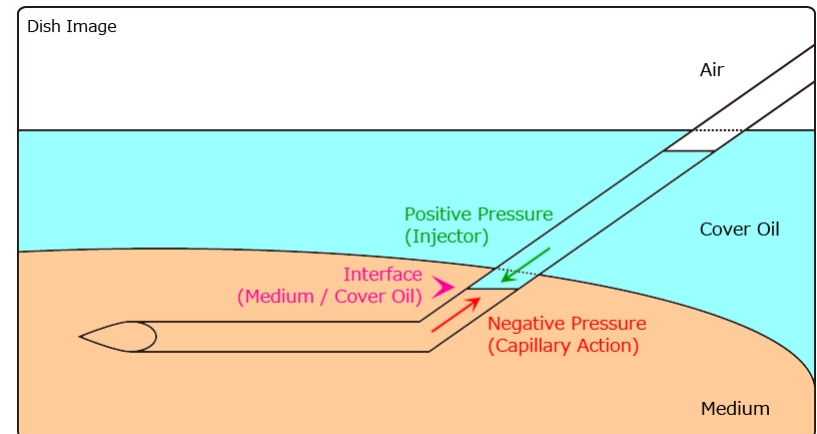

△ Hard to control. Too fast.

✓ The control speed (Response) depends on the positioning of interface.

# Summary

- ✓ When capillary action gets bigger than zero pressure at one atmospheric pressure inside of the injector, the pipette soaks up the oil/medium in the petri dish.

**Capillary action > Zero Pressure (at 1 atm.)**

- ✓ The capillary action, the negative pressure by phenomenon of nature, always occur. Interface needs to be balanced by applying the positive pressure with the control knob.

**Capillary action = Positive Pressure**

- ✓ Possibly, the capillary action soaks the oil/medium up to the tubing and injection holder. Make sure to take the pipette out from the oil/medium of the petri dish.

# INFORMATION



<http://narishige-group.com>

No part of this material may be reproduced and distributed in any form or by any means.  
Copyright © 2012 NARISHIGE GROUP. All rights reserved.